



Oil-Free Rotary-Screw Air Compressors

37-300 kW (50-400 hp)



More Than Air, a History of Innovation

1906 Ingersoll Rand becomes publicly traded company on NYSE



1933 Technologically advanced oil-free reciprocating compressor goes to market

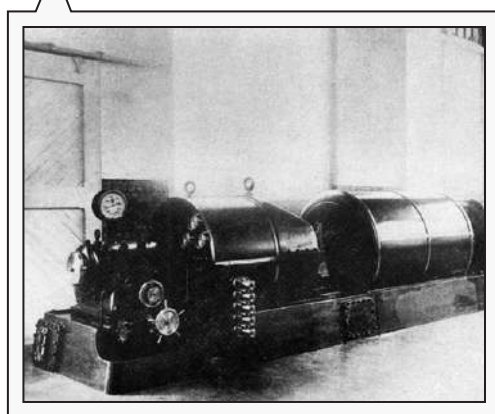
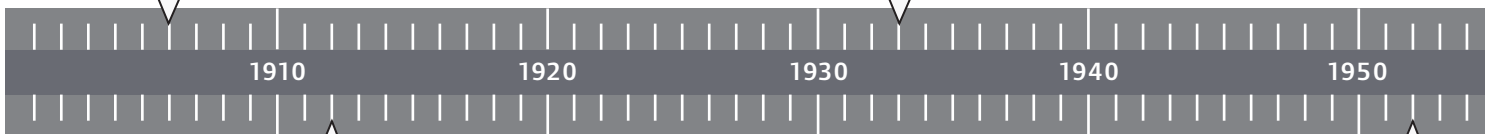
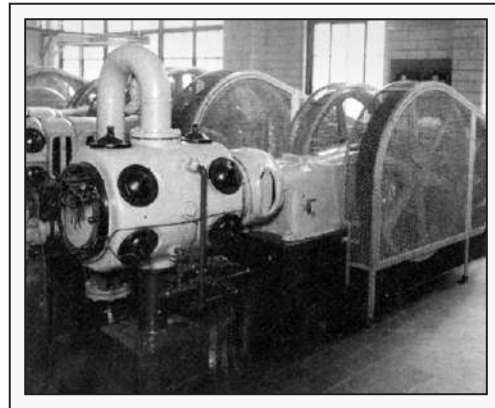

1912 Ingersoll Rand pioneers oil-free centrifugal compressor technology

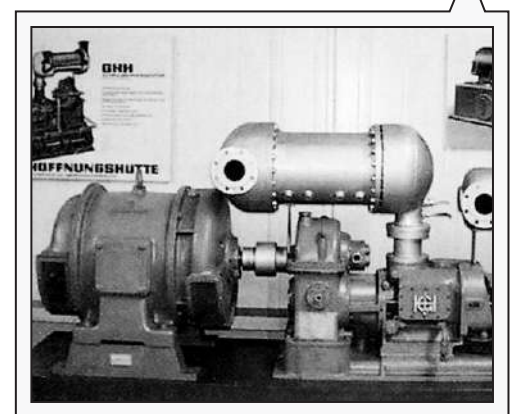

1952 The world's first oil-free rotary compressor is introduced

For more than 100 years, Ingersoll Rand has inspired progress by driving innovation with revolutionary technology — creating new standards for how the world gets work done. We introduced our first oil-free compressor in 1912, and over the decades we've continued to develop rugged, reliable, industry-leading compressor technologies.

Ingersoll Rand is the technology leader in oil-free compressed air not only because we develop class-leading products, but also because we know our customers' industries, understand the demands placed on productivity and quality, and then offer highly engineered system solutions that make sense. No matter what your product, process, or location, Ingersoll Rand has the expertise, the oil-free technology, and the unmatched service to meet your needs.

2003 Ingersoll Rand offers industry's first true variable-speed drive, oil-free compressor featuring HPM® motor technology

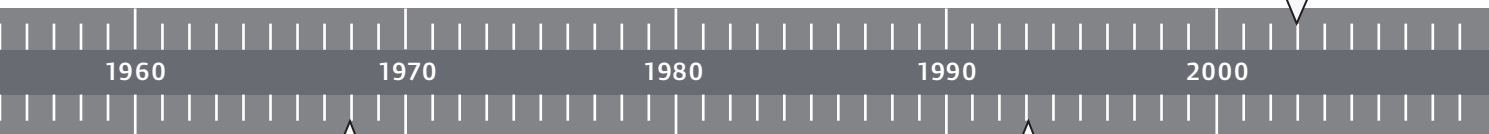
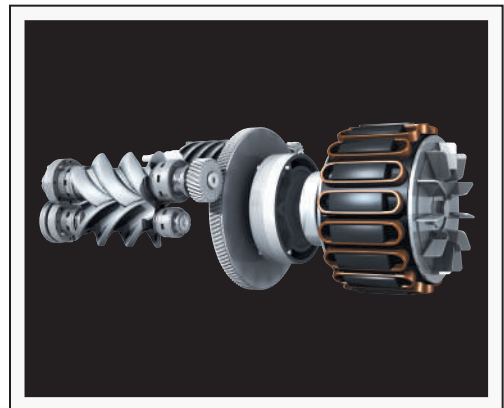

1968 First packaged centrifugal compressor is introduced (current model shown)



1993 The 37 – 300 kW packaged rotary-screw compressor introduced featuring Intellisys™, UltraCoat™ rotor protectant, and 46°C design

When High Air Purity is a High Priority



Food and Beverage ▲

Oil-free compressors that deliver no oil into the air stream and minimize microbial content through high-temperature compression reduce contamination risk for food and beverage manufacturers.



Pharmaceutical ▲

The highly regulated pharmaceutical industry requires 100% total quality built into manufacturing processes. Compressed air quality must be validated as part of GMP.

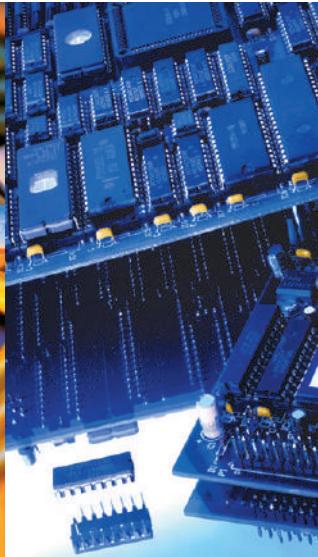

Electronics ▲

High air quality is critical in this industry — you can't afford downtime or product spoilage with wet or oily compressed air.

There's a lot riding on the quality of your air. The presence of particles, condensation, oil, and oil vapor in a compressed air system can lead to downtime, product spoilage and recall, damage to your brand reputation, or worse, harmed consumers and product liability.



Chemical ▲

Whether manufacturing cleaning solutions, base stock pharmaceuticals, or anything in between, the compressed air quality must be of the highest purity to minimize risk of production interruption or higher cost liability.



Textile ▲

High-tech air jet looms require super clean, dry, 100% oil-free compressed air, which is why Ingersoll Rand has been a critical supplier to this industry for many years.



Utilities ▲

Compressed air quality is too important to risk, so when specifying instrument air for utilities, most engineers request oil-free compressors.

No matter what industry or critical application, you can count on Ingersoll Rand to offer solutions that mitigate risk and ensure delivery of the highest air purity possible.

Oil-Free, Risk-Free

How pure is your air? One of the keys to ensuring you achieve and maintain acceptable air quality for your critical application is to know industry air quality standards and their allowable levels of contaminants. The lower the particular class rating, the purer the air should be.

ISO 8573-1:2010 Air Quality Classes							
Quality Class	Solids			Water Pressure Dew Point		Oil & Oil Vapor	
	Max Number of Particles Per m ³ 0.1 - 0.5 microns	0.5 - 1 microns	1 - 5 microns	°F	°C	mg/m ³	Quality Class
0	As specified by the end-user or manufacturer, and more stringent than Class 1						0
1	100	1	0	-100	-70	0.01	1
2	100,000	1,000	10	-40	-40	0.1	2
3	N/A	1,000	500	-4	-20	1	3
4	N/A	N/A	1,000	37.4	3	5	4
5	N/A	N/A	20,000	44.6	7	N/A	5
6	N/A	N/A	N/A	50	10	N/A	6

ISO 8573-1:2001 Class 0 specifies air quality standards for critical manufacturing processes within the food and beverage, pharmaceutical, textile, and electronics industries. It is the most stringent class, covering oil contamination in aerosol, vapor, and liquid forms.

Some compressor manufacturers have marketed their units as being **essentially** oil-free, but this isn't necessarily the case. If you need **guaranteed** pure air for your critical application, then you need Ingersoll Rand.



UltraCoat™ — Energy Savings and Longer Life

Compressor rotors take a beating. Over time their surfaces can deteriorate, making rotors increasingly susceptible to compressed air impurities and temperature fluctuation, which lead to reduced efficiency, decreased air purity, and compressor failure.

Ingersoll Rand eliminates this problem with UltraCoat, an advanced rotor and housing protection process that ensures the most durable coating, with unmatched adhesion and temperature resistance.

Every Ingersoll Rand oil-free rotor and housing is specially prepared, creating a surface texture to which the UltraCoat micro-coating bonds with the tightest, longest-lasting grip possible.

We also use stainless-steel and aluminum piping to link the compressor's intercooler with the stainless-steel second stage rotors. This way, condensation during the cooling process won't cause corrosion or rust, further extending the life of the UltraCoat coating and rotors.

Ultimately, UltraCoat delivers greater reliability in performance and air quality, rotor longevity, increased uptime, and reduced energy costs.

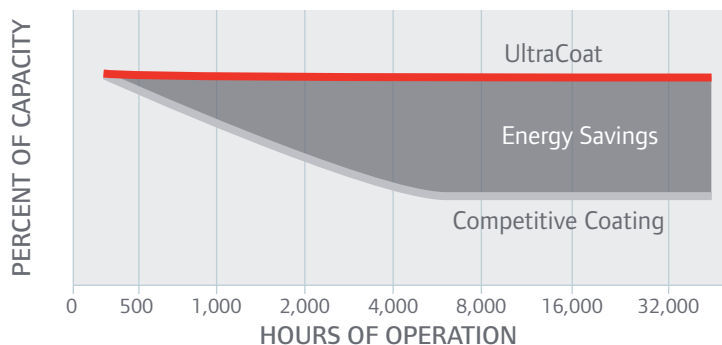

Unleashing the Full Potential of Variable-Speed Technology

If you have a critical oil-free application

requiring the lowest operating cost, you can't afford to take chances with a compressor system that delivers anything but the absolute highest quality air, reliability, and efficiency. Not a problem with an Ingersoll Rand Nirvana — the world's first true variable-speed drive (VSD) oil-free compressor system.



Purely better

While other variable-speed drive (VSD) compressors also deliver stable pressure, soft-starting, and improved part-load efficiency over fixed-speed compressors, only Nirvana enables you to reach the full potential of variable-speed technology. With a Nirvana system, you get ultra-reliability and efficiency, virtually maintenance-free operation, unlimited starts and stops, and peace of mind knowing your air is 100% pure.

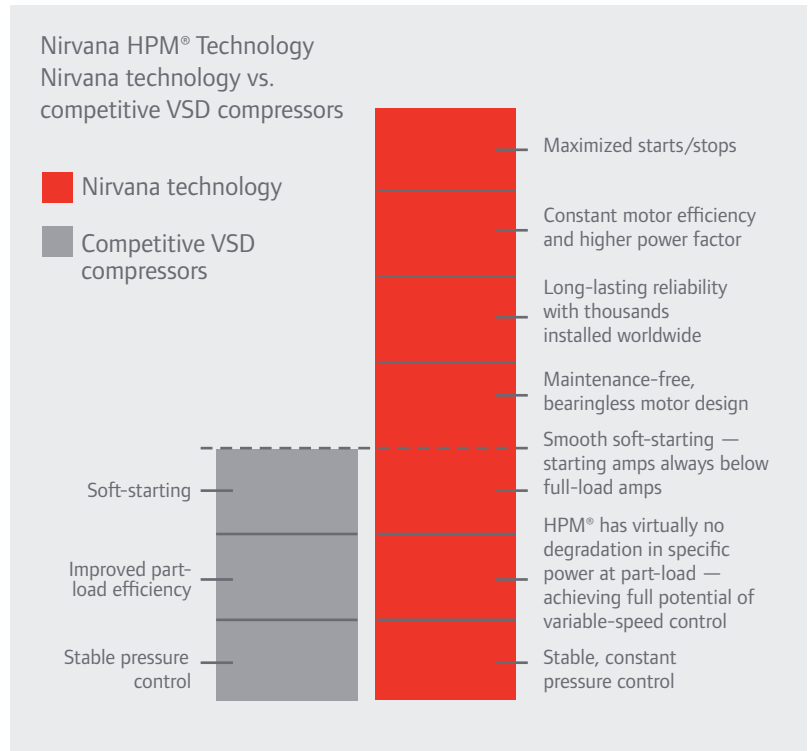

Real savings, real satisfaction

Energy costs can be as much as 60% of the lifecycle cost of an air compressor. The Nirvana system helps you reach the full potential of variable speed through the absolute lowest energy cost and the highest efficiency possible.

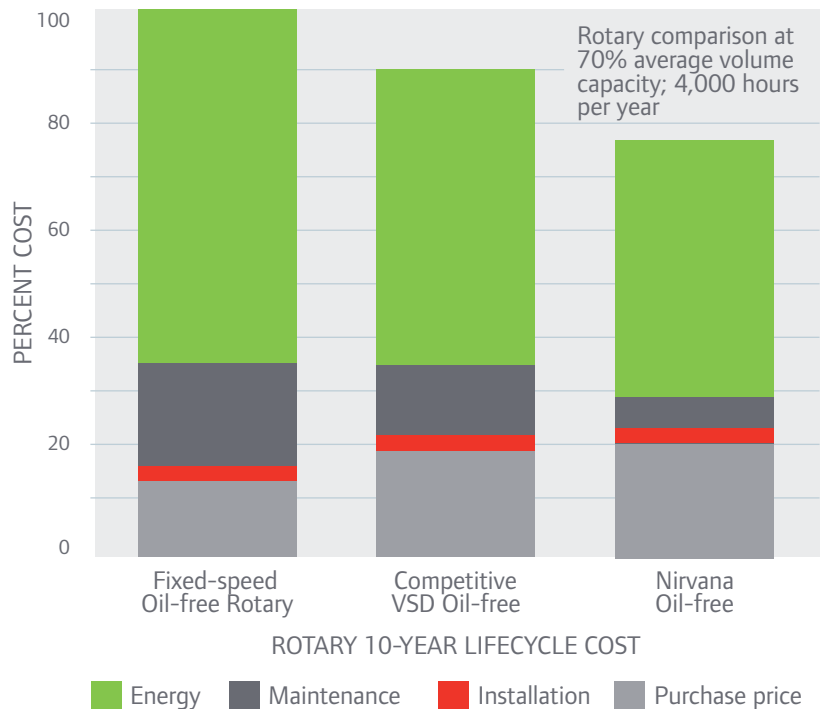

Achieve a Higher Plane of Performance

There's never been a compressor system as advanced as Nirvana. It's synergy in motion — a combination of transcendent, inter-dependent technologies including the revolutionary Hybrid Permanent Magnet® (HPM®) motor, and more than a century of proven engineering expertise and innovation.

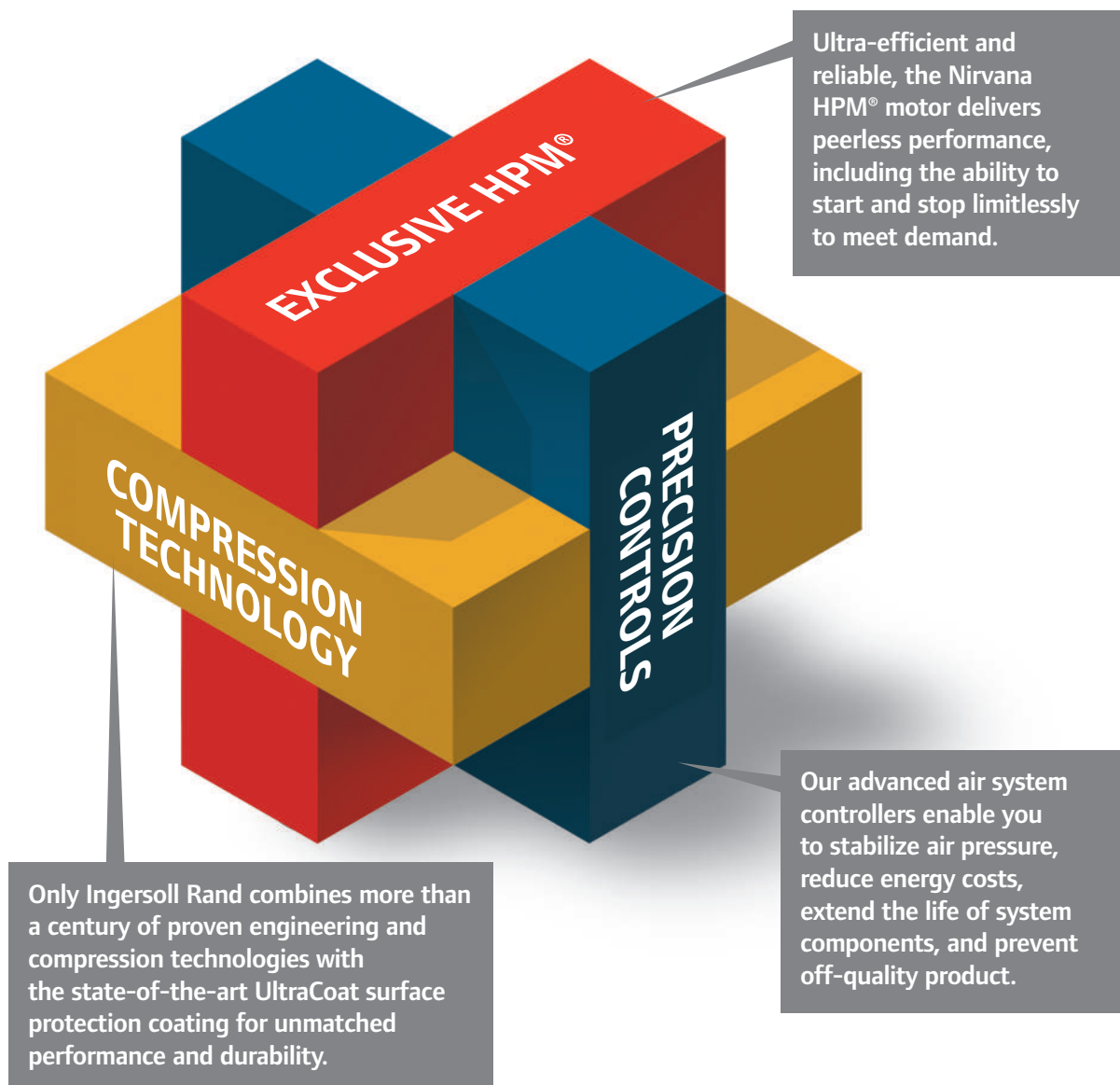

50 Hz and 60 Hz Specifications

50 Hz

Model (HPM® Style)	FAD (m ³ /min) at 7 bar g	FAD (m ³ /min) at 8.6 bar g	FAD (m ³ /min) at 10.3 bar g	Discharge Air BSPT in	Nominal kW	Width kW	Length mm	Height mm	Weight kg
IRN37K-OF	5.66	5.07	N/A	1.5	37	1,120	2,080	2,030	1,632
IRN45K-OF	6.71	6.20	N/A	1.5	45	1,120	2,080	2,030	1,632
IRN55K-OF	9.37	8.47	7.62	1.5	55	1,320	2,080	1,950	2,045
IRN75K-OF	12.32	11.33	10.42	1.5	75	1,320	2,080	1,950	2,045
IRN90K-OF	15.10	13.40	12.10	2.0	90	1,830	2,570	2,440	3,222
IRN110K-OF	18.50	16.70	15.40	2.0	110	1,830	2,570	2,440	3,222
IRN132K-OF	21.50	20.10	18.60	2.0	132	1,830	2,570	2,440	3,222
IRN160K-OF	25.60	24.10	22.80	2.0	160	1,830	2,570	2,440	3,222

Model (Induction/ Inverter Style)	FAD (m ³ /min) at 7 bar g	FAD (m ³ /min) at 8.6 bar g	FAD (m ³ /min) at 10.3 bar g	Discharge ANSI in	Nominal kW	Width kW	Length mm	Height mm	Weight kg
S250-VSD	45.2	40.5	35.5	4.0	250	1,930	3,050	2,440 (air-cooled)	4,760
S300-VSD	48.8	46.7	43.3	4.0	300	1,930	3,050	2,030 (water-cooled)	4,902

Models S250 and S300-VSD include the inverter shipped loose for mounting in motor control room or location of customer preference. Inverter Unit is pre-engineered for plug-and-play and is 2000 mm H x 600 mm L x 538 mm W.

60 Hz

Model (HPM® Style)	FAD at 100 psig cfm	FAD at 125 psig cfm	FAD at 150 psig cfm	Discharge Air BSPT in	Nominal hp	Width in	Length in	Height in	Weight lb
IRN50H-OF	200	180	N/A	1.5	50	44.0	82.0	80.0	3,590
IRN60H-OF	237	220	N/A	1.5	60	44.0	82.0	80.0	3,590
IRN75H-OF	331	299	269	1.5	75	52.0	81.8	76.7	4,500
IRN100H-OF	435	400	368	1.5	100	52.0	81.8	76.7	4,500
IRN125H-OF	563	504	444	2.0	125	72.0	81.8	76.7	4,500
IRN150H-OF	676	616	555	2.0	150	72.0	101.0	96.1	7,088
IRN200H-OF	881	816	750	2.0	200	72.0	101.0	96.1	7,088

Model (Induction/ Inverter Style)	FAD at 100 psig cfm	FAD at 125 psig cfm	FAD at 150 psig cfm	Discharge ANSI in	Nominal hp	Width in	Length in	Height in	Weight lb
350-VSD	1,600	1,501	1,330	4.0	350	-	-	-	10,485
400-VSD	1,730	1,650	1,501	4.0	400	-	-	-	10,785

Models 350 and 400-VSD include the inverter shipped loose for mounting in motor control room or location of customer preference. Inverter Unit is pre-engineered for plug-and-play and is 78.7" H x 23.6" W x 21.2" D.

Perfect Solutions For Critical Operations

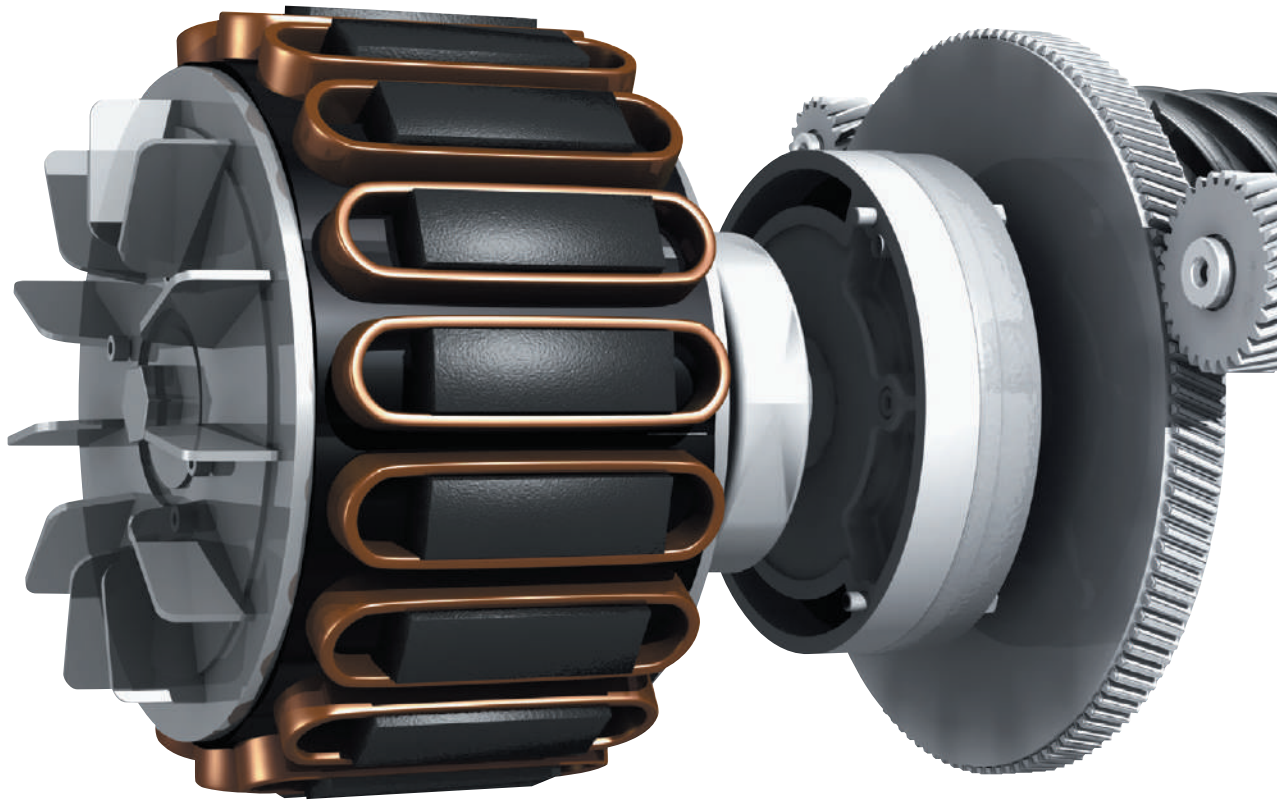

Limitless starts and stops

Nirvana is designed to start and stop limitlessly to meet your compressed air demands while never going above full-load amps. HPM® motor technology also has unmatched efficiency throughout the turn-down range, providing savings no matter what your demand profile requires.

No wasted energy

The Nirvana HPM® motor requires less power at start-up, never operates at more than full-load amps, and shuts down immediately at minimum speed to avoid wasted energy. Nirvana ensures constant pressure throughout the entire operating range. At start-up, induction motors require a power surge of up to twice full-load current in order to overcome initial inertia. They also run unloaded when demand is below minimum, reducing efficiency and driving up energy costs.

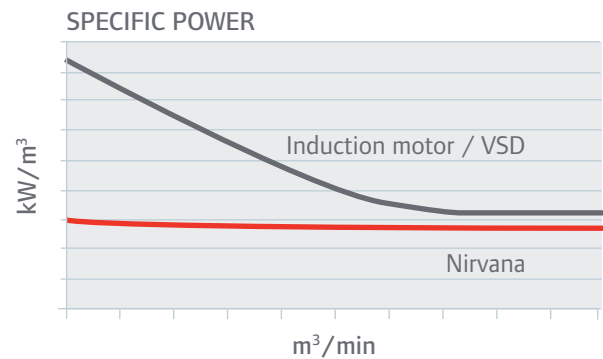



A revolutionary motor coupled with advanced controls and proven compressor technologies.

Proven airends

Our rotary-screw airends deliver full potential through unparalleled rotor profile accuracy and repeatability. Stainless-steel rotors are used in the demanding second stage for maximum corrosion resistance. UltraCoat surface coating is also applied to the rotors and all housing surfaces for unmatched durability and performance.

Simpler and more reliable

The Nirvana HPM® motor has fewer moving parts, and flanges directly onto the compressor drive shaft, making the motor more reliable and 100% maintenance-free. Its bearing-free design eliminates the need for greasing or replacing motor bearings. The HPM® motor is also designed to operate continuously in temperatures up to 46°C (115°F).



Precision-wound

With its precision-wound design, the Nirvana HPM® motor eliminates inefficiencies and hot spots common to conventional, random-wound induction motors. These hot spots can cause insulation and motor failure.

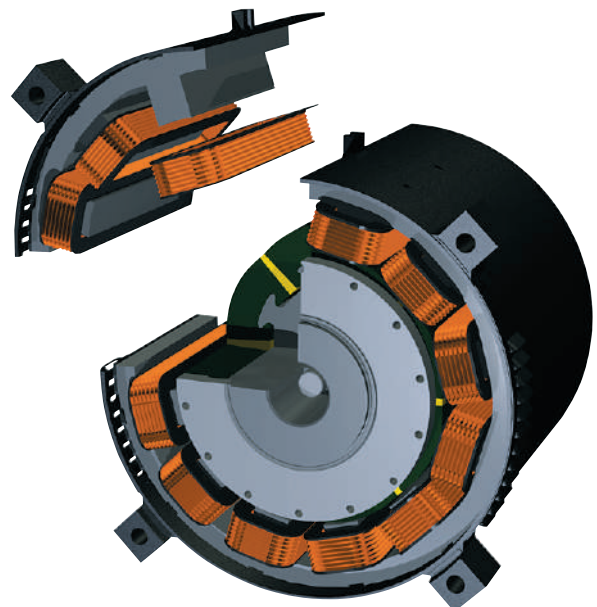

Two-Stage, Oil-Free Rotary-Screw Air Compressors

The reliable workhorse

Since its introduction in 1993, the Ingersoll Rand oil-free rotary-screw compressor has earned a reputation for being a highly reliable supplier of pure air. Its rugged design sets the standard for efficiency and durability. With an Ingersoll Rand oil-free rotary-screw compressor in your operation, you benefit from knowing you can run 24-hours-a-day, seven-days-a-week with virtually no downtime.

Superior technology

Our time-proven, two-stage compression module features precision-machined rotors and gearing, advanced UltraCoat rotor protection, anti-friction bearings, stainless-steel air seals, and a unique labyrinth oil seal design — all ensuring years of reliable, trouble-free operation.

Oil-free heritage

Over the years, Ingersoll Rand has delivered more than 100,000 sets of oil-free rotors to industries that rely on high-purity products such as pharmaceuticals, food and beverages, and electronics.

Stainless-steel rotors

Ingersoll Rand pioneered the use of stainless-steel rotors in the demanding second stage to guarantee longer airtight life, and to safeguard the quality of your compressed air.

Inlet valve superiority

Ingersoll Rand uses hydraulic valve actuation instead of pneumatic controls. This eliminates the need for periodic diaphragm replacement, preventing unnecessary downtime and maintenance costs.

Dual-vented seals

Our stainless-steel ring seals and labyrinth oil seals provide dual-vented, 100% guaranteed oil-free air.

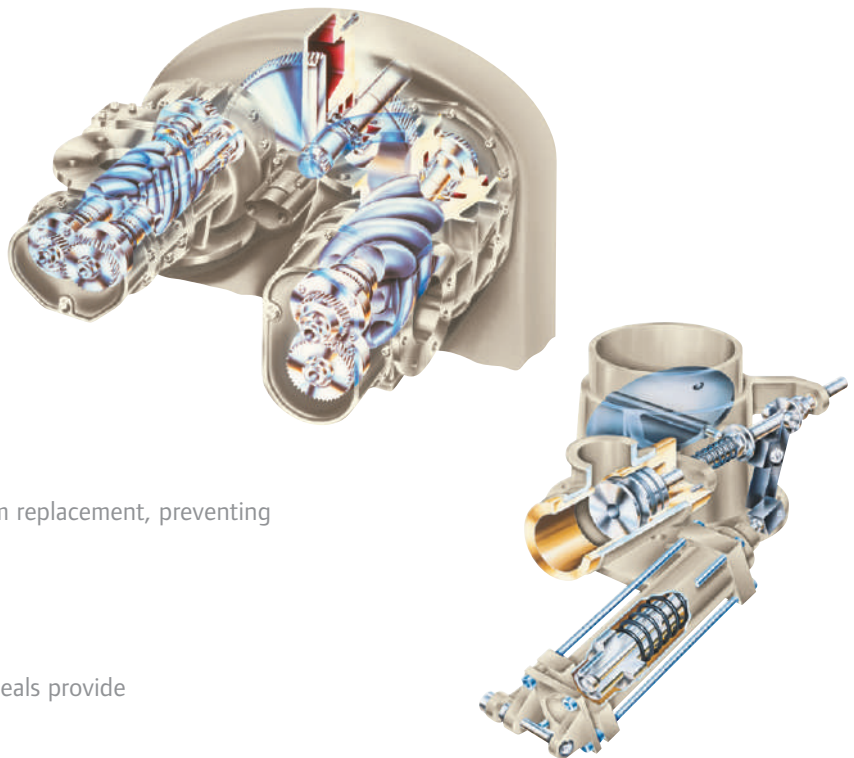

50 Hz and 60 Hz Specifications

50 Hz (37 – 300 kW)

Nominal kW	Model SL FAD (m ³ /min) at 7.0 bar g	Model SM FAD (m ³ /min) at 8.5 bar g	Model SH FAD (m ³ /min) at 10.0 bar g	Width mm	Length mm	Height mm	Weight kg
37	6.0	5.1	N/A	1,372	2,248	1,914	2,387/2,410*
45	7.7	6.5	N/A	1,372	2,248	1,914	2,497/2,520*
55	9.6	8.8	7.8	1,372	2,248	1,914	2,577/2,600*
75	12.7	11.6	10.8	1,372	2,248	1,914	2,682/2,705*
90	16.1	13.6	13.0	1,588	2,692	2,362/1,84*	3,040/3,195*
110	19.4	18.0	15.4	1,588	2,692	2,362/1,84*	3,095/3,250*
132	22.8	21.4	18.8	1,588	2,692	2,362/1,84*	3,274/3,429*
150	25.9	24.6	22.1	1,588	2,692	2,362/1,84*	3,275/3,430*
200	35.0	32.6	28.5	1,930	3,048	2,438/2,032*	4,186
250	45.2	41.5	36.0	1,930	3,048	2,438/2,032*	4,306
300	48.8	48.0	43.3	1,930	3,048	2,438/2,032*	4,366

60 Hz (50 – 400 hp)

Nominal hp	Model L FAD at 100 psig cfm	Model H FAD at 125 psig cfm	Model HH FAD at 150 psig cfm	Width in	Length in	Height in	Weight lb
50	216	186	N/A	54.0	88.5	75.4	5,111
60	268	232	N/A	54.0	88.5	75.4	5,364
75	336	290	268	54.0	88.5	75.4	5,364
100	424	411	390	54.0	88.5	75.4	5,500
125	586	524	477	62.5	106.0	93.3/72.5*	6,437/6,709*
150	691	691	566	62.5	106.0	93.3/72.5*	6,452/6,724*
200	912	855	760	62.5	106.0	93.3/72.5*	7,099/7,385*
250	1,200	1,080	935	76.0	120.0	96.0/80.0*	8,820
300	1,398	1,264	1,165	76.0	120.0	96.0/80.0*	9,090
350	1,600	1,501	1,400	76.0	120.0	96.0/80.0*	9,610
400	1,539	1,535	1,545	76.0	120.0	96.0/80.0*	9,610

FAD (Free Air Delivery) cfm and m³/min are full-package performance ratings in accordance with CAGI / Pneurop acceptance test standard PN2CPTC2 or ISO 1217:1996.

*Specification given with air-cooled valve first, then water-cooled.



Ingersoll Rand (NYSE:IR) advances the quality of life by creating comfortable, sustainable and efficient environments. Our people and our family of brands—including Club Car®, Ingersoll Rand®, Thermo King® and Trane®—work together to enhance the quality and comfort of air in homes and buildings; transport and protect food and perishables; and increase industrial productivity and efficiency. We are a \$13 billion global business committed to a world of sustainable progress and enduring results.



www.ingersollrandproducts.com

Distributed by:



Member of Pneurop



Ingersoll Rand, IR, the IR logo, Intellisys, UltraCoat and HPM are trademarks of Ingersoll Rand, its subsidiaries and/or affiliates. All other trademarks are the property of their respective owners.

Ingersoll Rand compressors are not designed, intended or approved for breathing air applications. Ingersoll Rand does not approve specialized equipment for breathing air applications and assumes no responsibility or liability for compressors used for breathing air service.

Nothing contained on these pages is intended to extend any warranty or representation, expressed or implied, regarding the product described herein. Any such warranties or other terms and conditions of sale of products shall be in accordance with Ingersoll Rand's standard terms and conditions of sale for such products, which are available upon request.

Product improvement is a continuing goal at Ingersoll Rand. Any designs, diagrams, pictures, photographs and specifications contained within this document are for representative purposes only and may include optional scope and/or functionality and are subject to change without notice or obligation.